



# Bài 1

## CÁC SỐ

### 0, 1, 2, 3, 4, 5

Giáo viên: .....

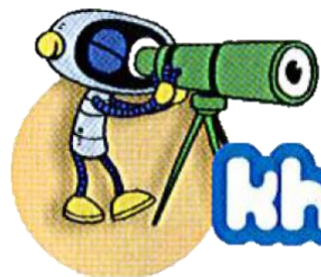

# Khám phá

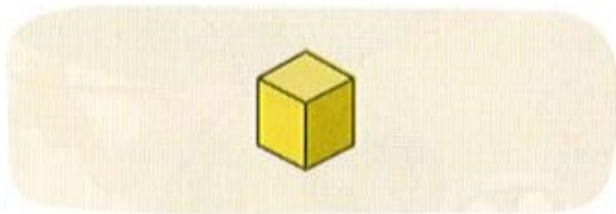

1



một

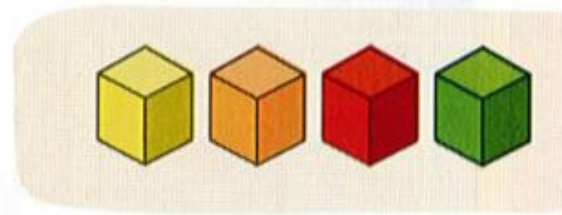

4



bốn

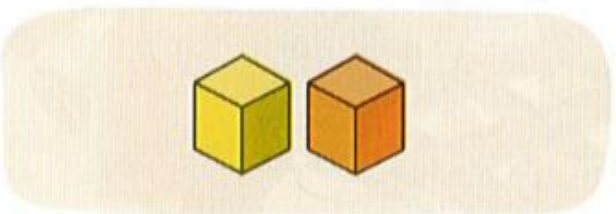

2



hai

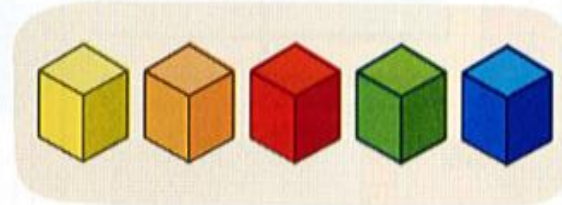

5



năm

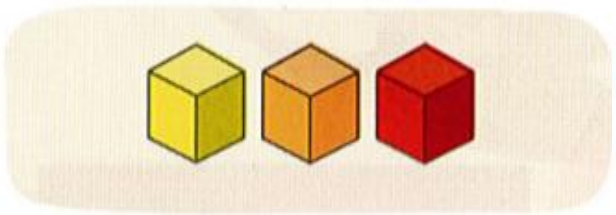

3



ba



0



không



# 1 Tập viết số

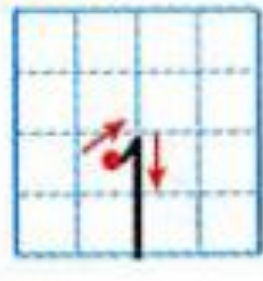



hoạt động

1 Tập viết số

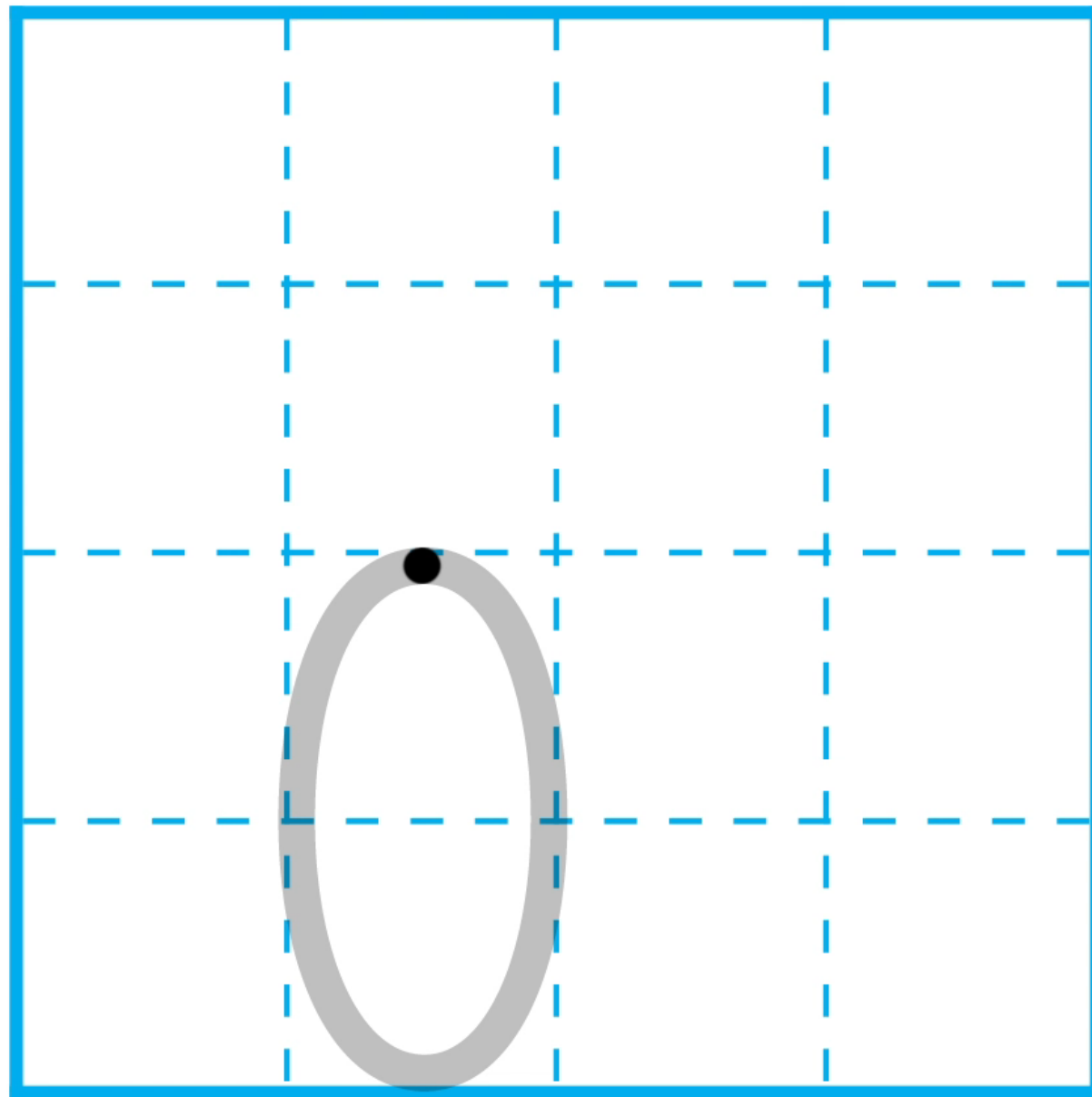
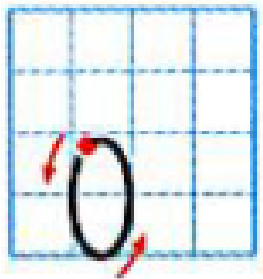



hoạt động

1 Tập viết số

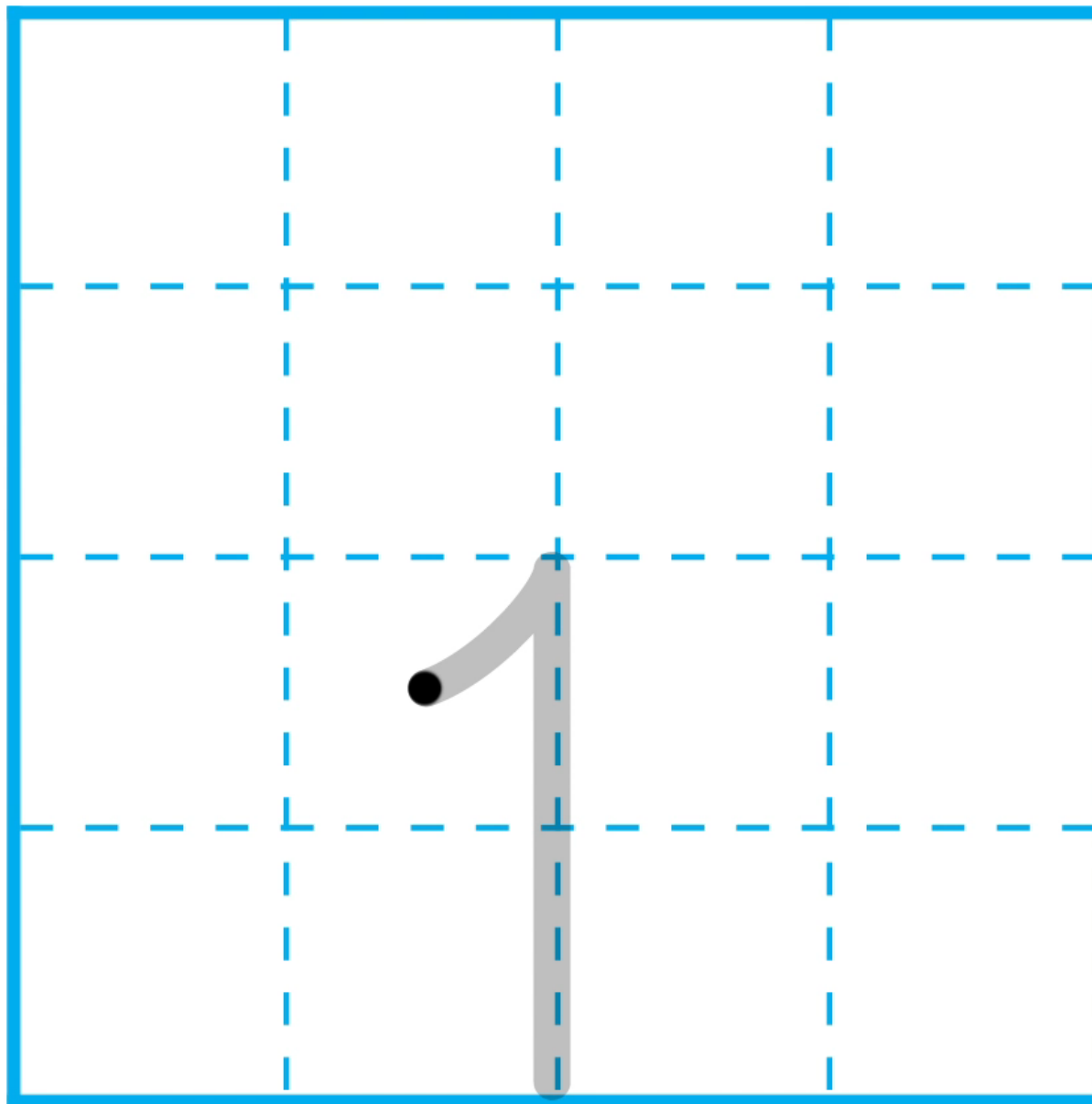
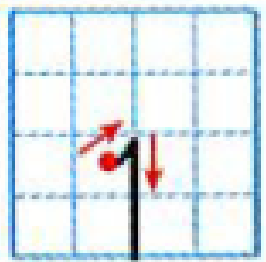



hoạt động

1 Tập viết số

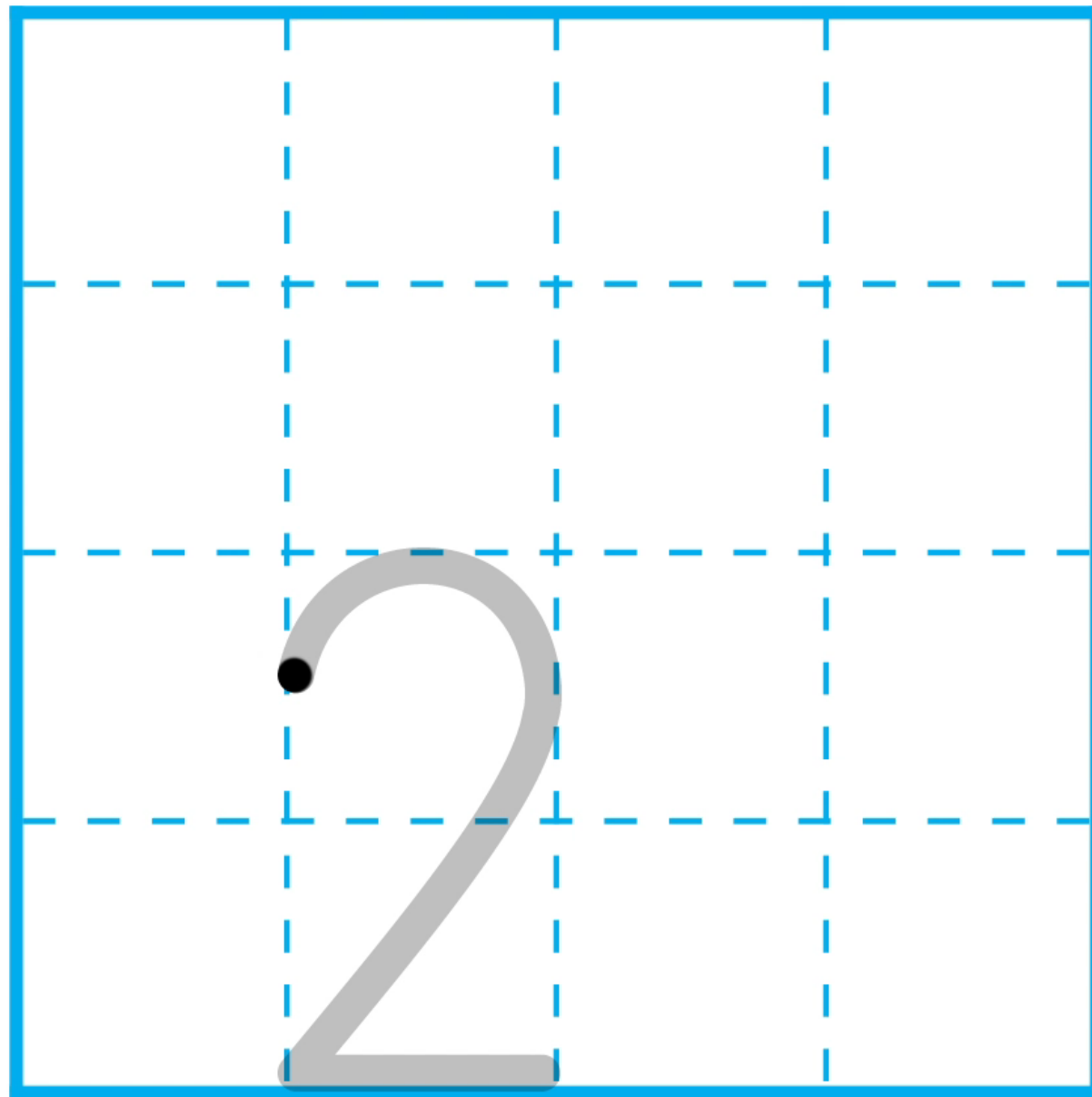
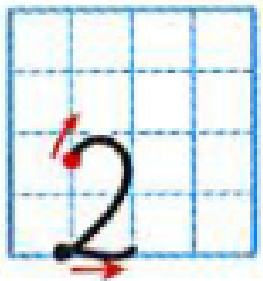



hoạt động

1 Tập viết số

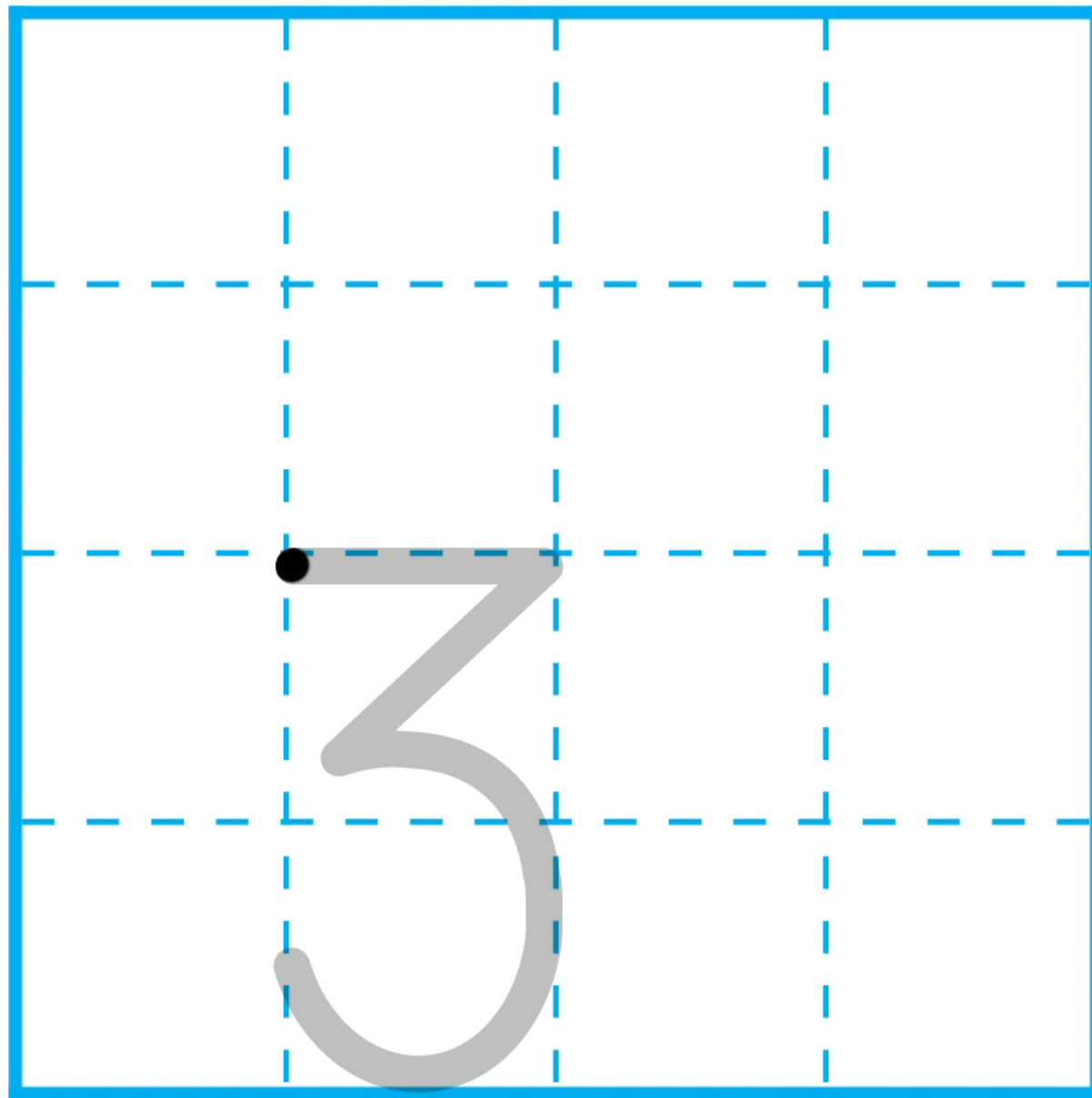



hoạt động

1 Tập viết số

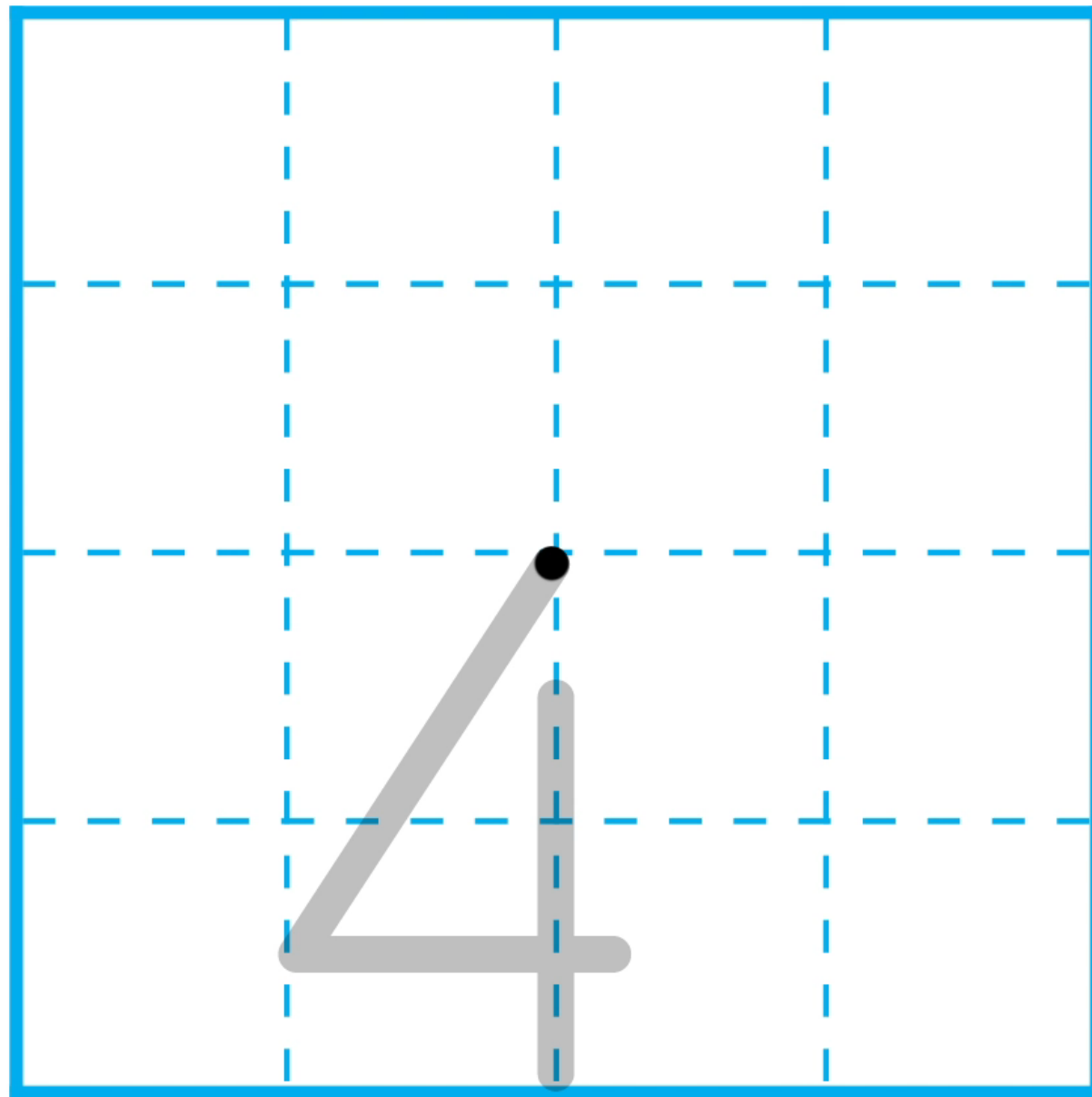
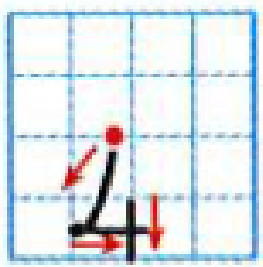



hoạt động

1 Tập viết số

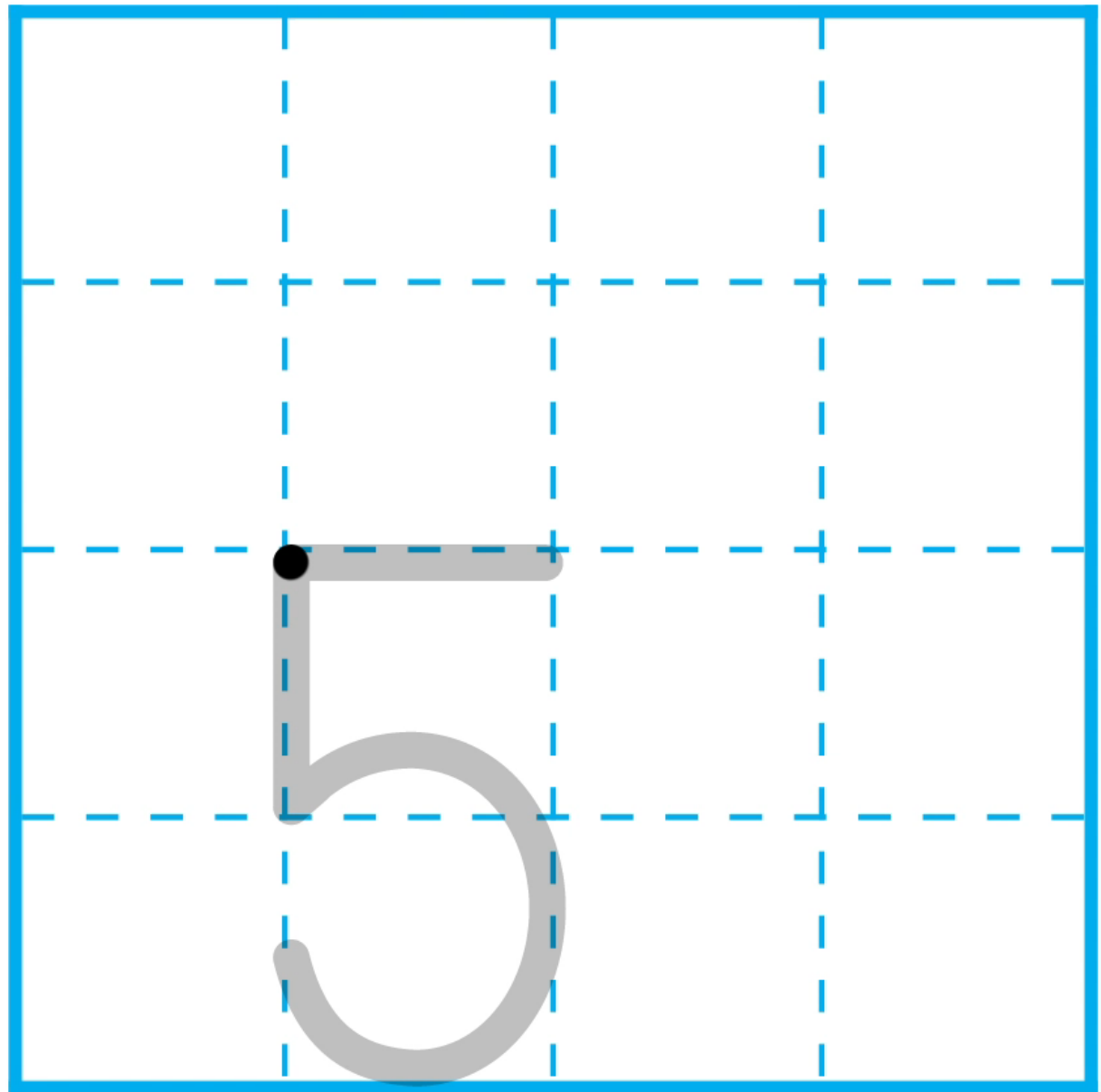
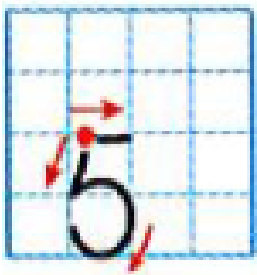



# hoạt động

2 Số ?

a)

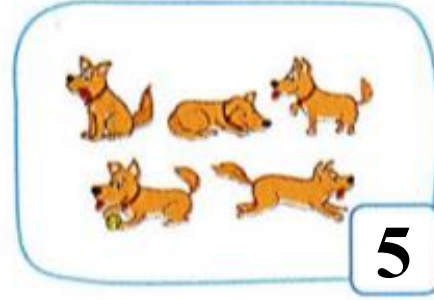
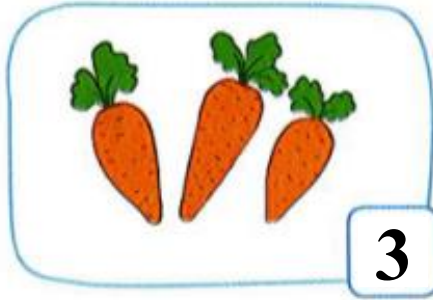
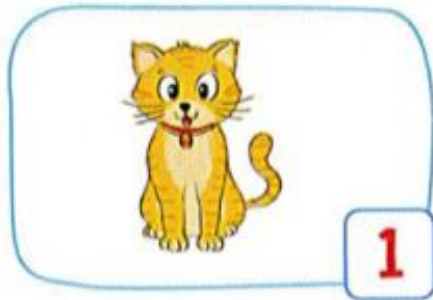

b)

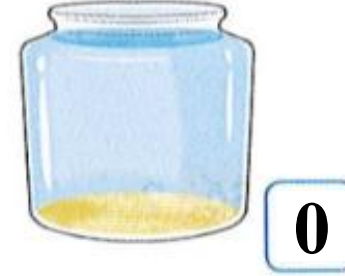



3 Số ?

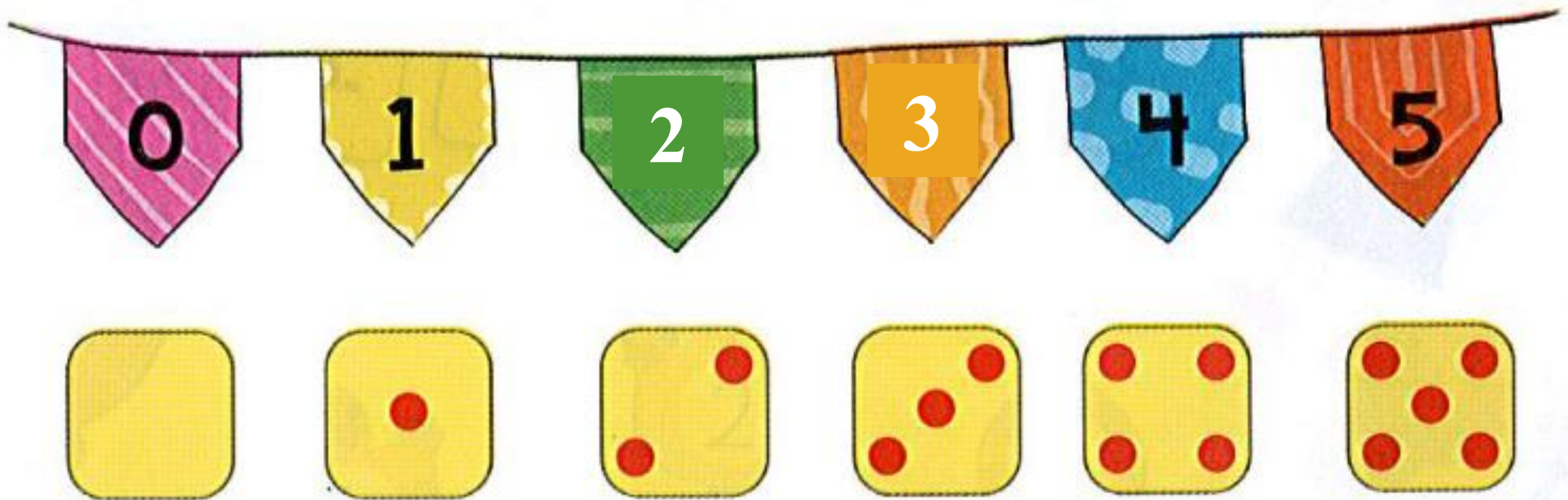



# luyện tập

1 Số ?



0



3



2

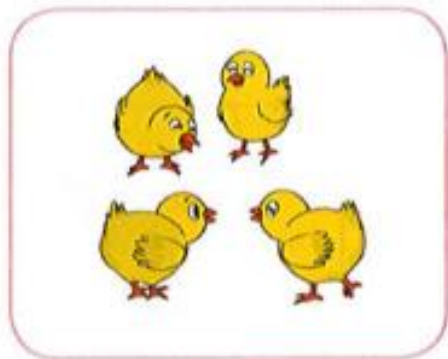

4



1

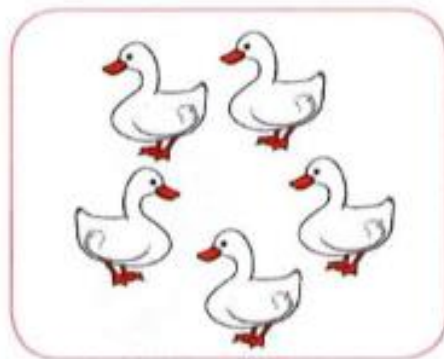

5

































2 Số ?





3 Có bao nhiêu củ cà  
rốt đã tô màu?

a)					
b)					
c)					
d)					
e)					
g)					

3

2

4

1

5

0



4 Có bao nhiêu con gà ghi số 2?

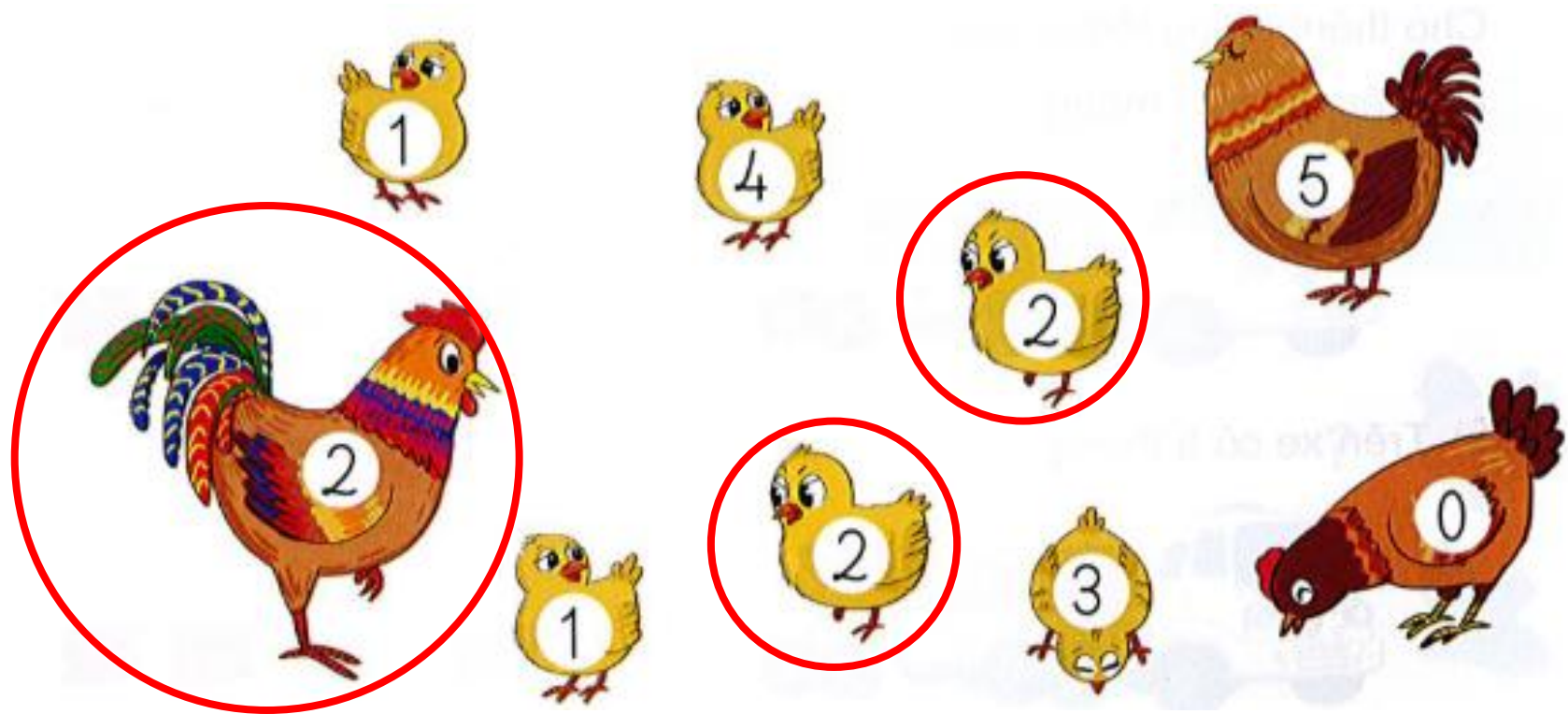



# luyện tập

1 Chọn số thích hợp





2 Tìm câu trả lời đúng

Cho thêm thùng lên xe đê:

a) Trên xe có 3 thùng.



b) Trên xe có 5 thùng.





3 Số?

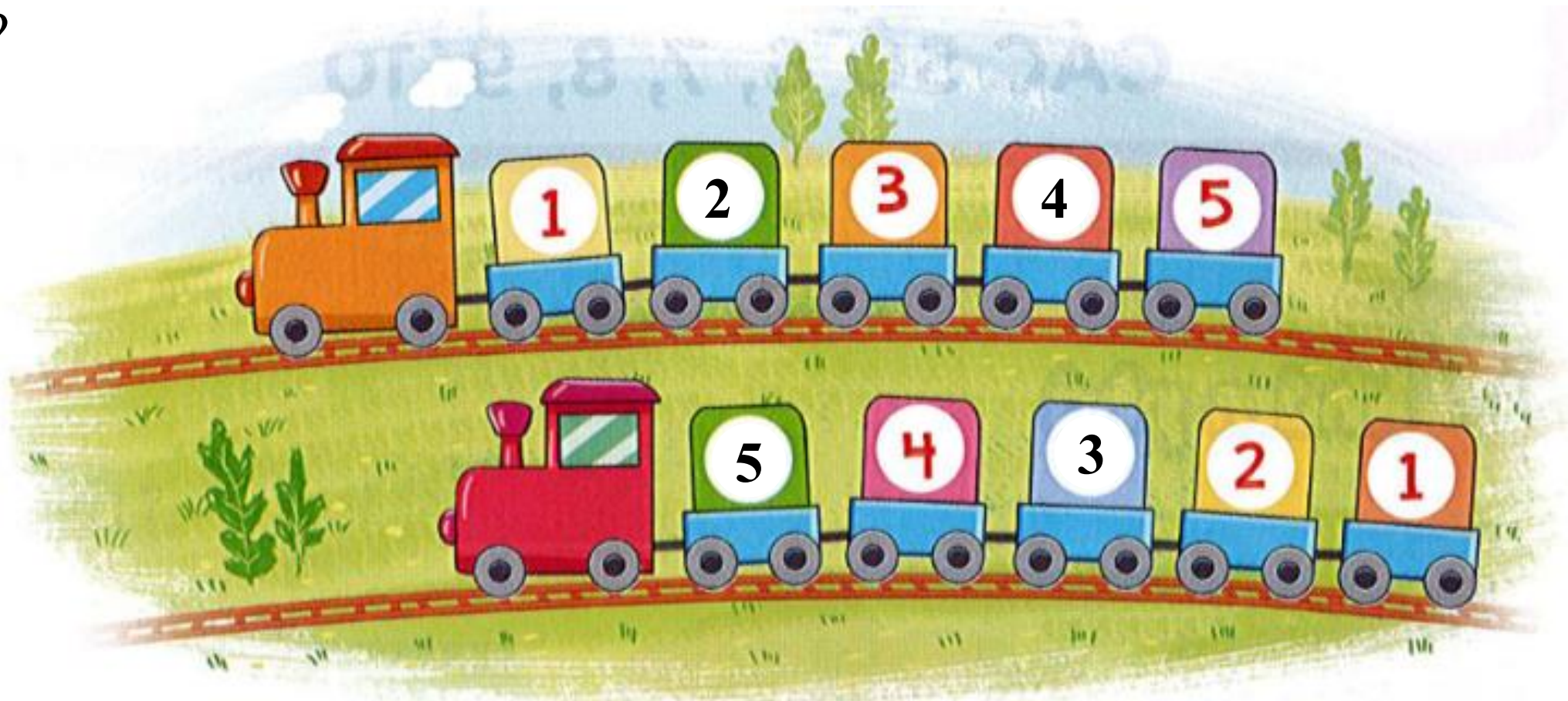



# luyện tập

## 4 Số?

2



3



5



1



4



0

